

Dénombrer : compter et écrire/coller tamponner le résultat (entre un et trois)

---

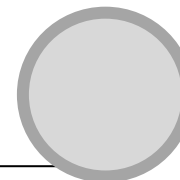
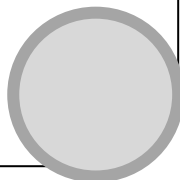
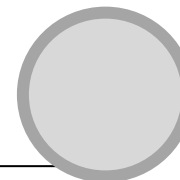
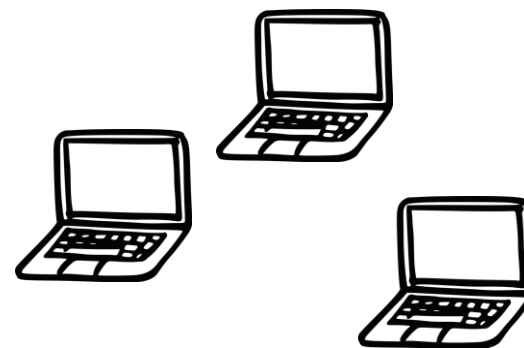
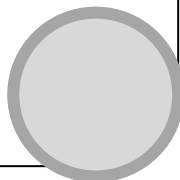

Dénombrer : compter et écrire/coller tamponner le résultat (entre zéro et trois)

---

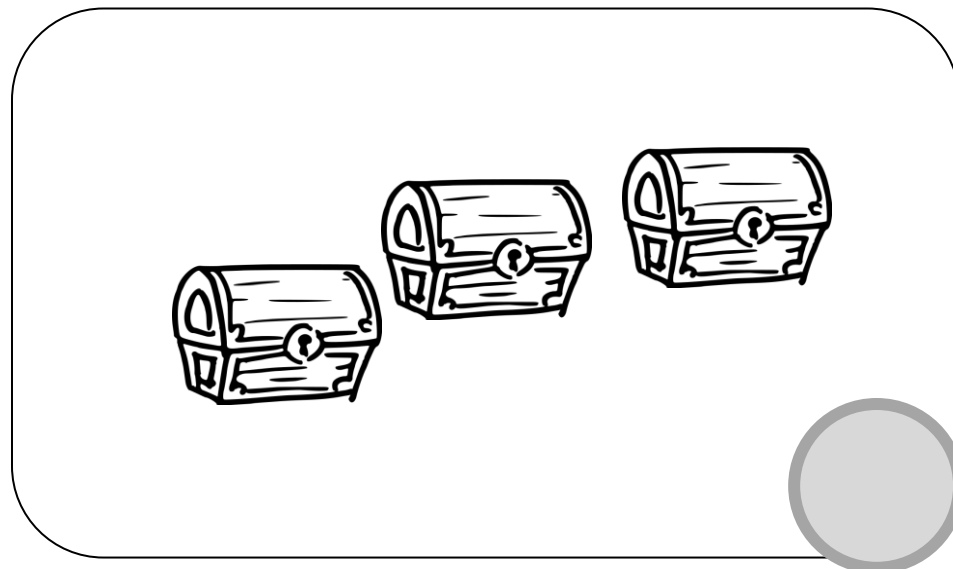
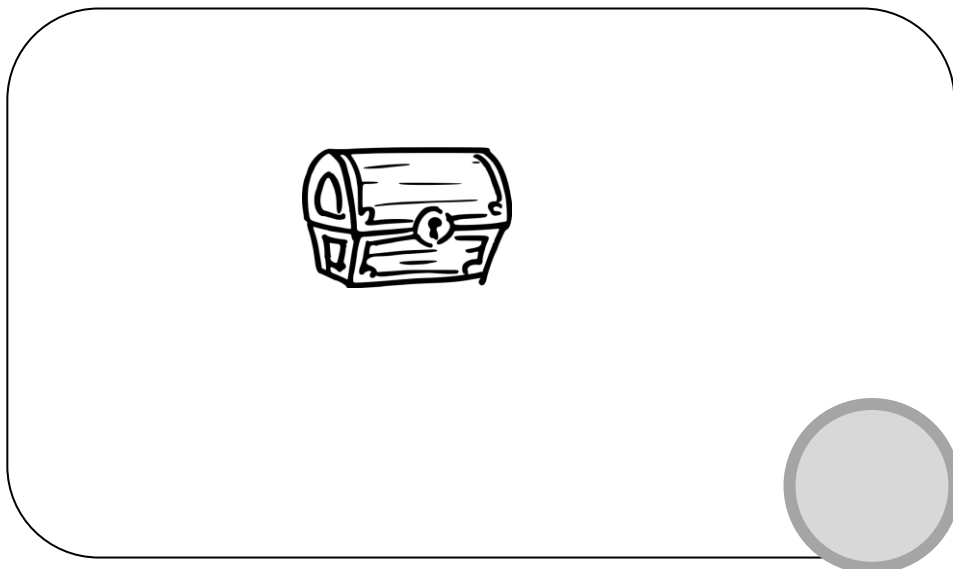
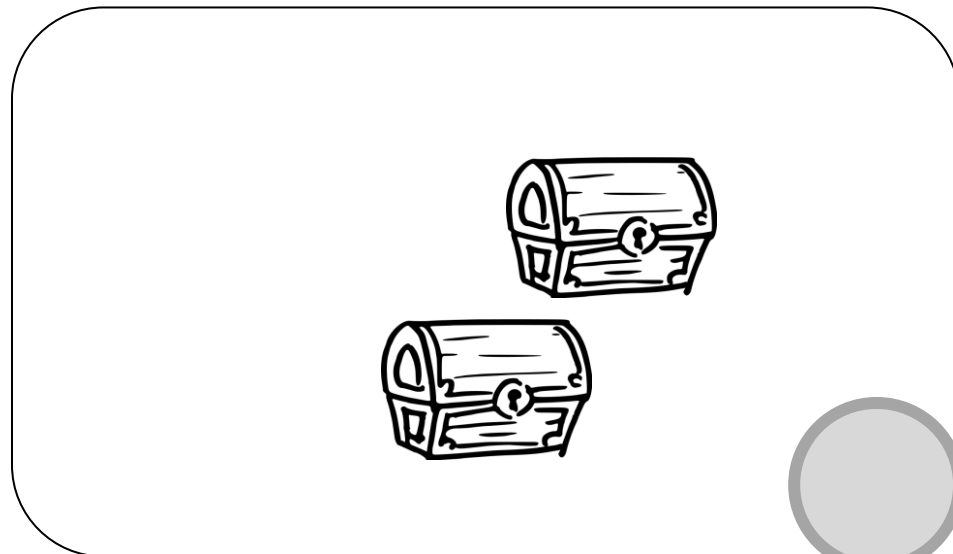

Dénombrer : compter et écrire/coller tamponner le résultat (entre un et trois)

---

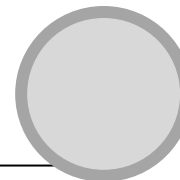
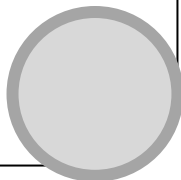
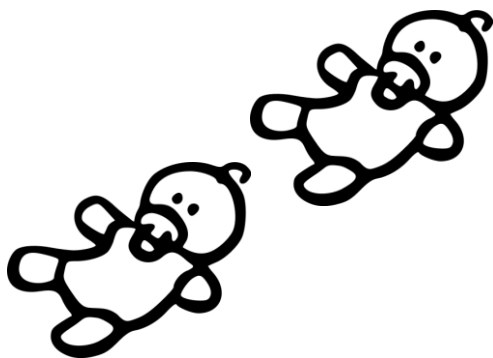
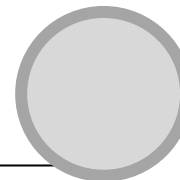
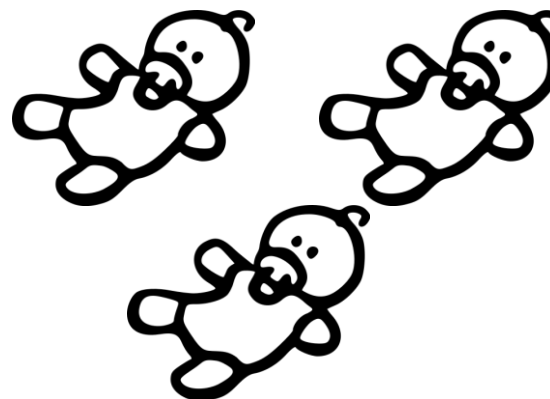
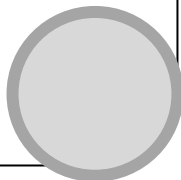

Dénombrer : compter et écrire/coller tamponner le résultat (entre un et trois)

---

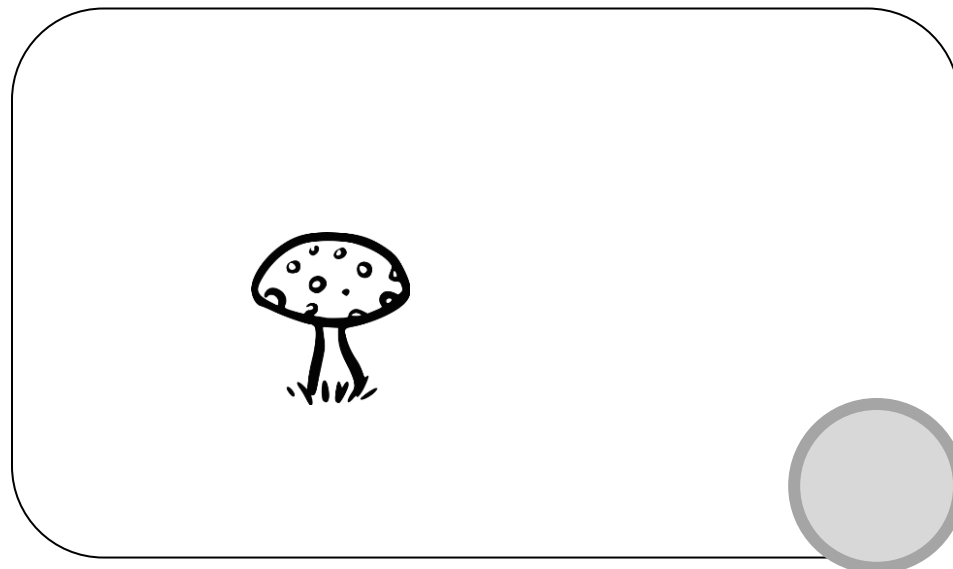
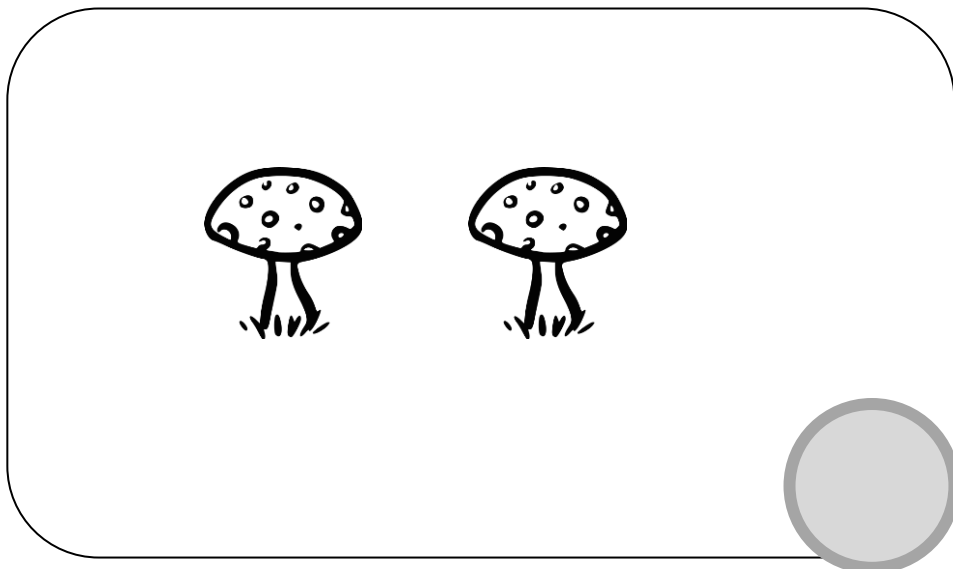
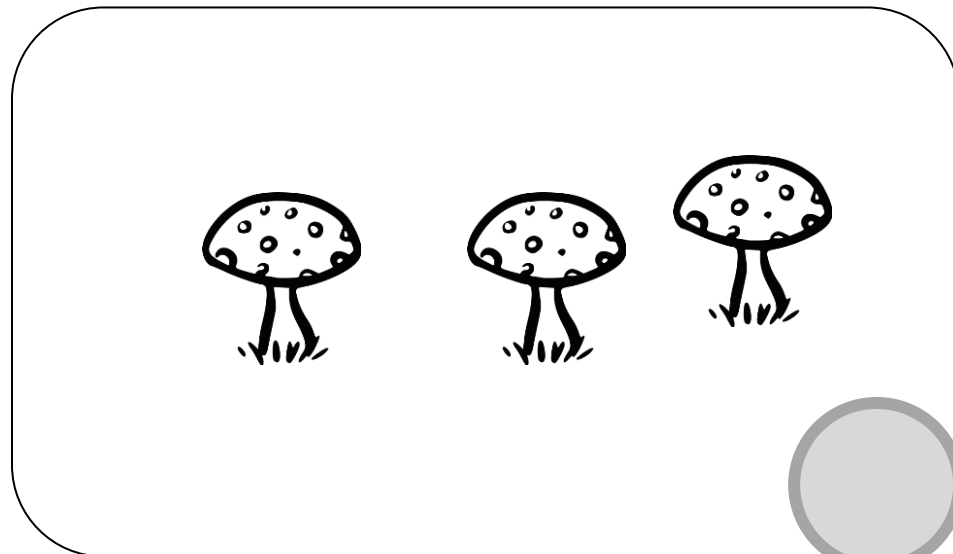

Dénombrement : compter et écrire/coller tamponner le résultat (entre un et trois)

---

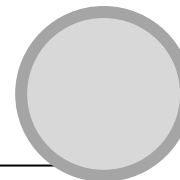
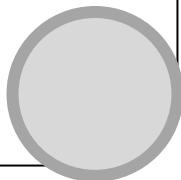
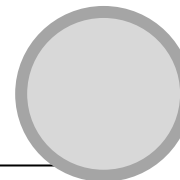
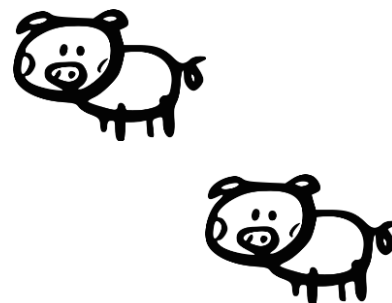
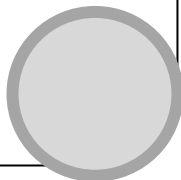
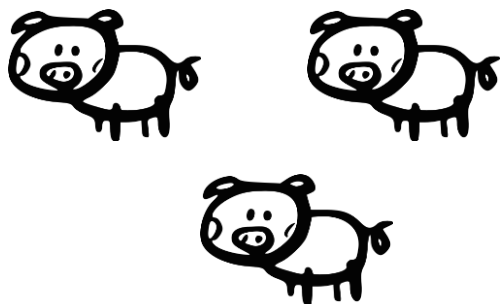

Dénombrer : compter et écrire/coller tamponner le résultat (entre un et trois)

---

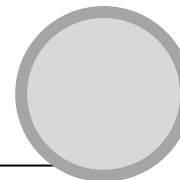
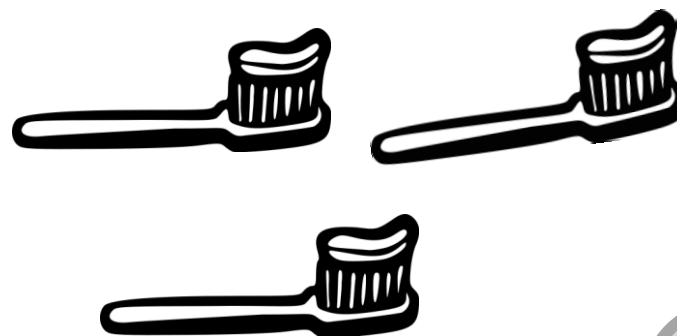
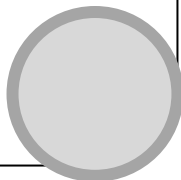
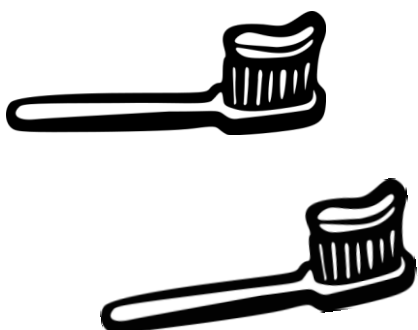
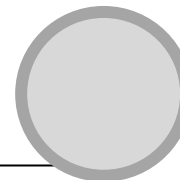
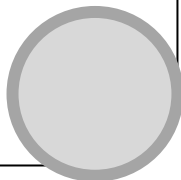
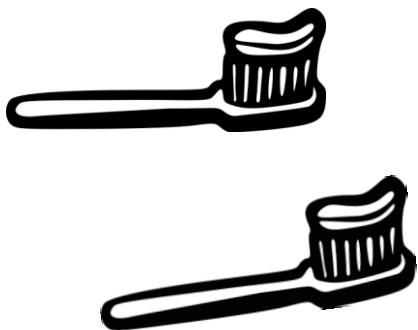

Dénombrer : compter et écrire/coller tamponner le résultat (entre un et trois)

---

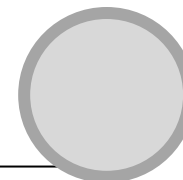
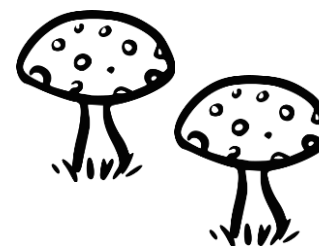
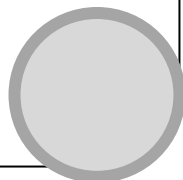
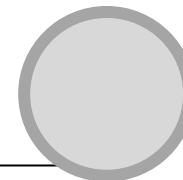
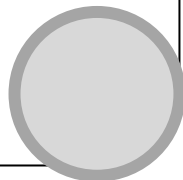

Dénombrement : compter et écrire/coller tamponner le résultat (entre un et trois)

---

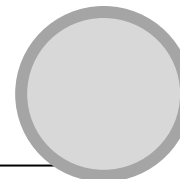
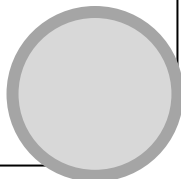
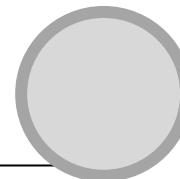
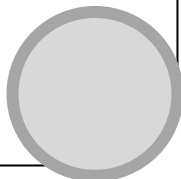



Dénombrer : compter et écrire/coller tamponner le résultat (entre un et trois)

---

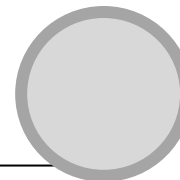
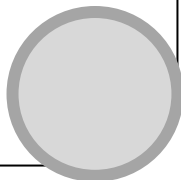
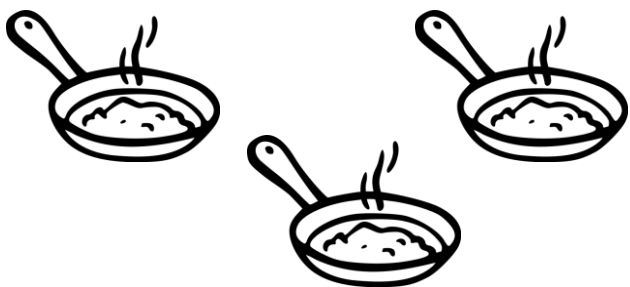
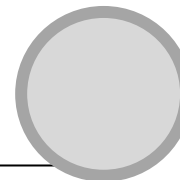
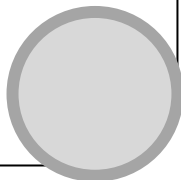
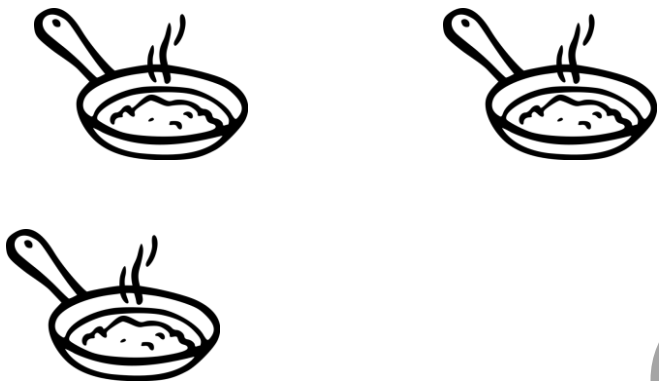

Dénombrer : compter et écrire/coller tamponner le résultat (entre un et trois)

---

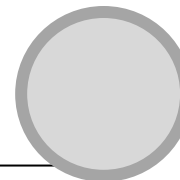
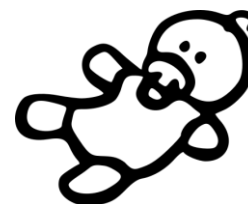
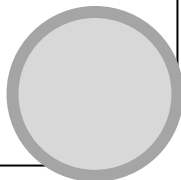
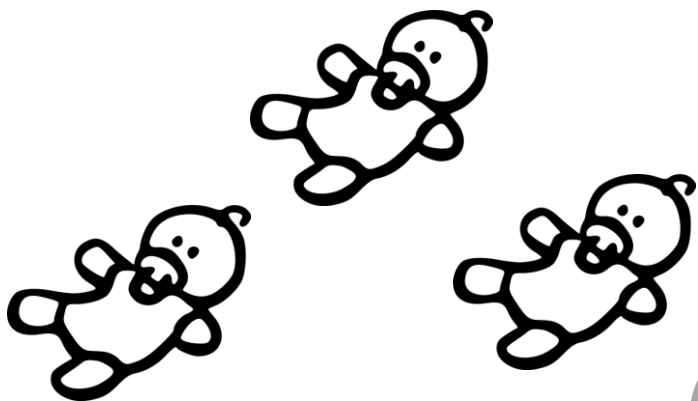
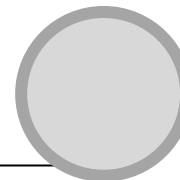
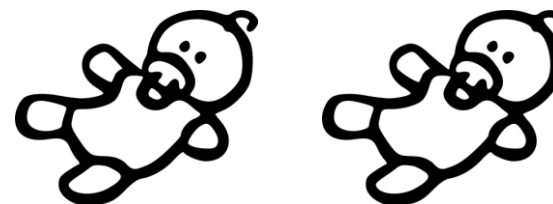
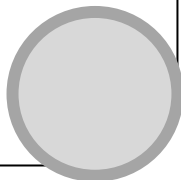
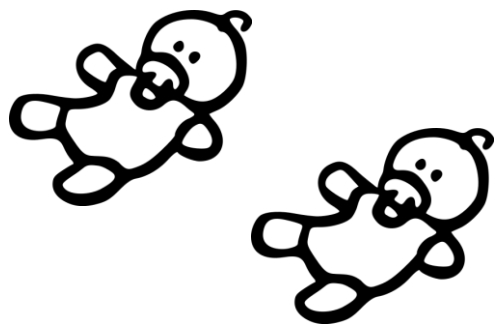

Dénombrer : compter et écrire/coller tamponner le résultat (entre un et trois)

---

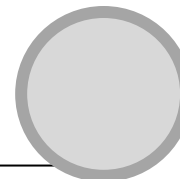
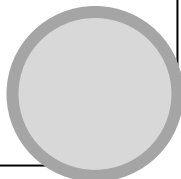
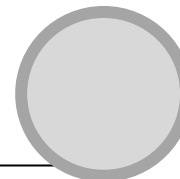
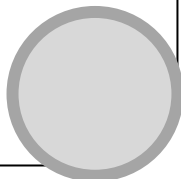

Dénombrer : compter et écrire/coller tamponner le résultat (entre un et trois)

---

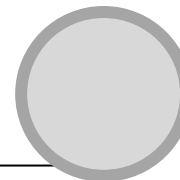
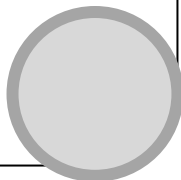
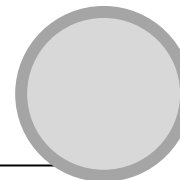
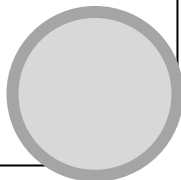
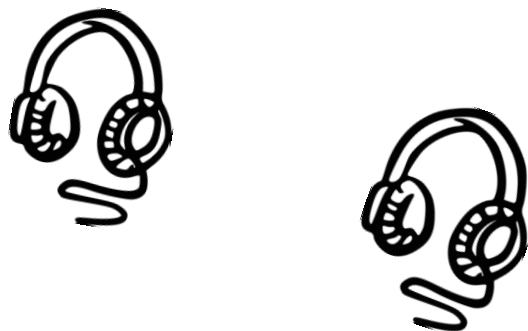

Dénombrement : compter et écrire/coller tamponner le résultat (entre zéro et trois)

---

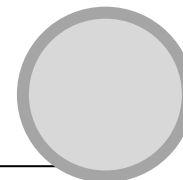
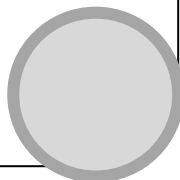
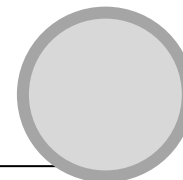
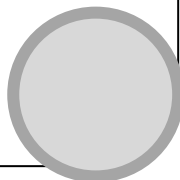

Dénombrement : compter et écrire/coller tamponner le résultat (entre zéro et trois)

---

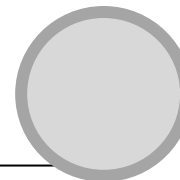
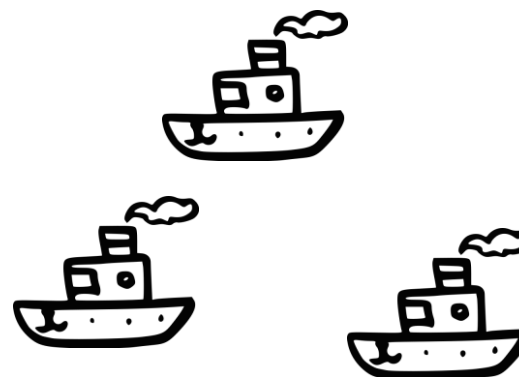
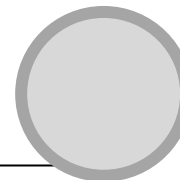
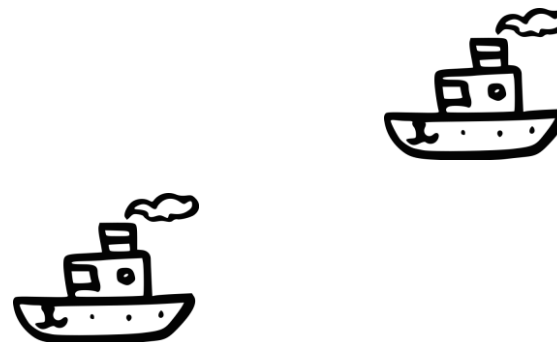
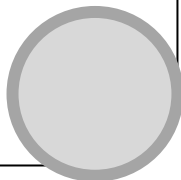
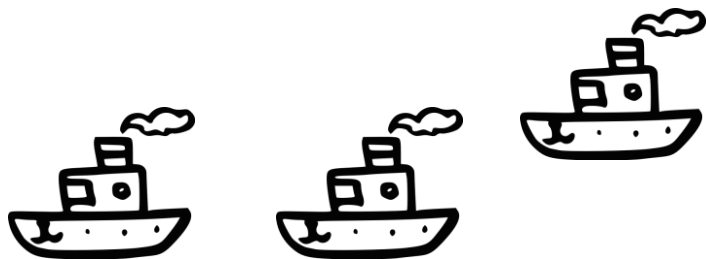

Dénombrer : compter et écrire/coller tamponner le résultat (entre un et trois)

---

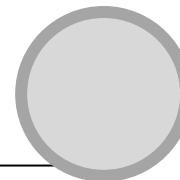
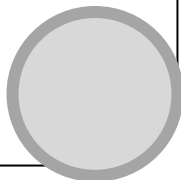
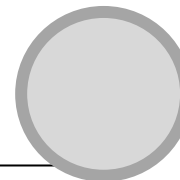
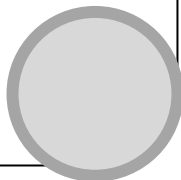

Dénombrer : compter et écrire/coller tamponner le résultat (entre zéro et trois)

---

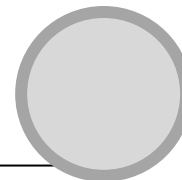
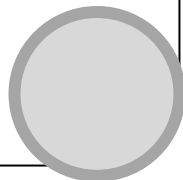
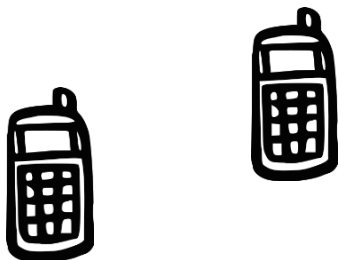
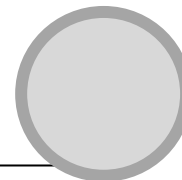
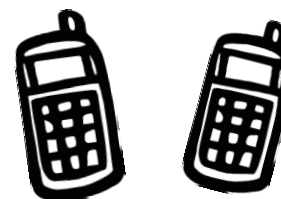
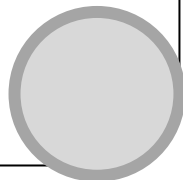
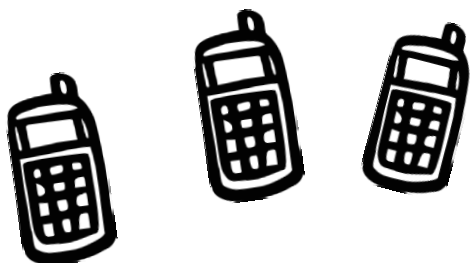



Dénombrer : compter et écrire/coller tamponner le résultat (entre zéro et trois)

---

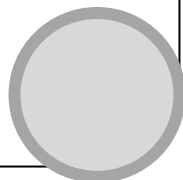
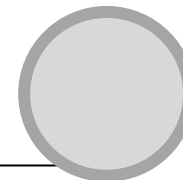
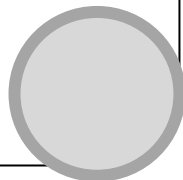

Dénombrer : compter et écrire/coller tamponner le résultat (entre zéro et trois)

---

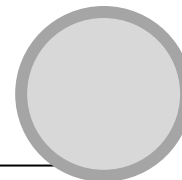
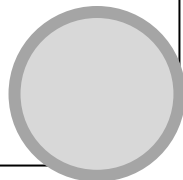
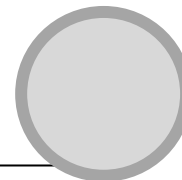
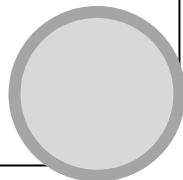

Dénombrer : compter et écrire/coller tamponner le résultat (entre un et trois)

---

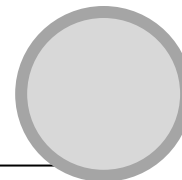
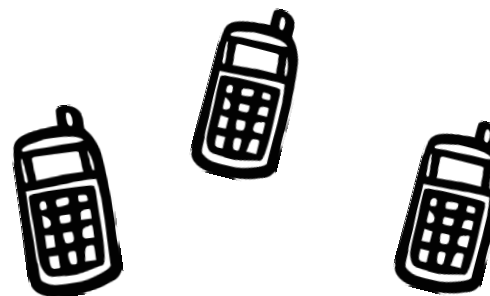
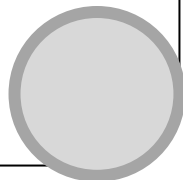
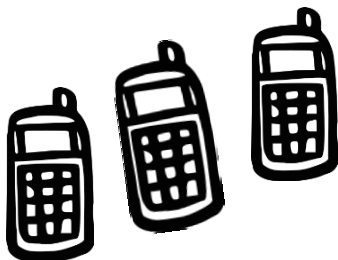
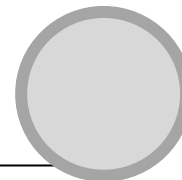
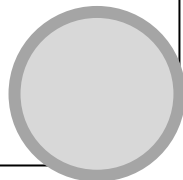
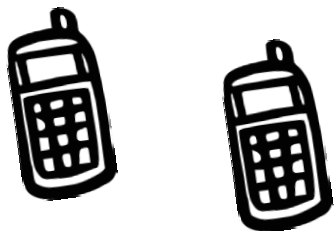

Dénombrer : compter et écrire/coller tamponner le résultat (entre zéro et trois)

---

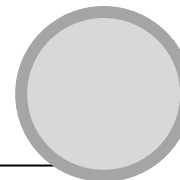
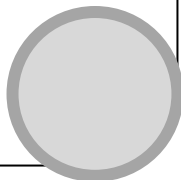
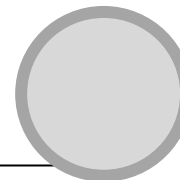
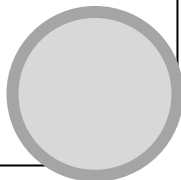
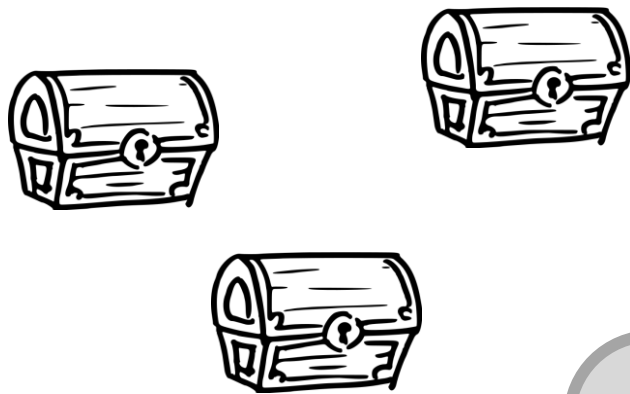

Dénombrement : compter et écrire/coller tamponner le résultat (entre zéro et trois)

---

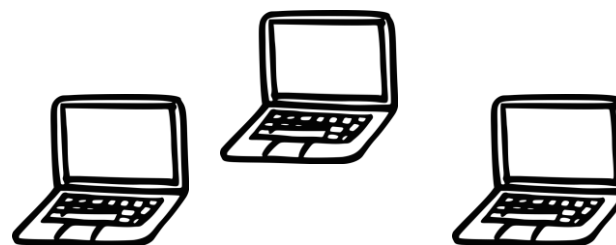
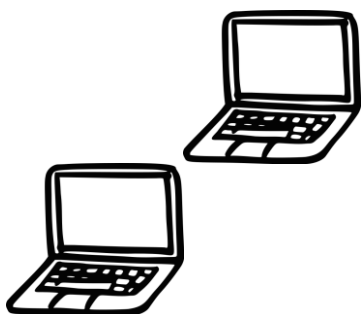

Dénombrer : compter et écrire/coller tamponner le résultat (entre un et trois)

---

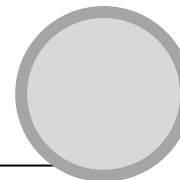
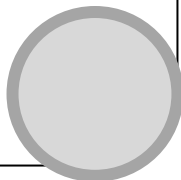
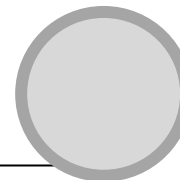
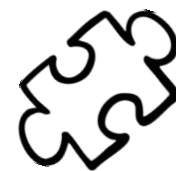
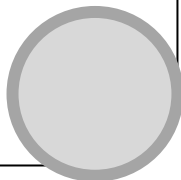
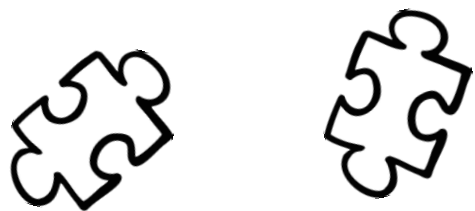

Dénombrer : compter et écrire/coller tamponner le résultat (entre zéro et trois)

---

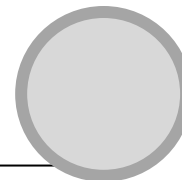
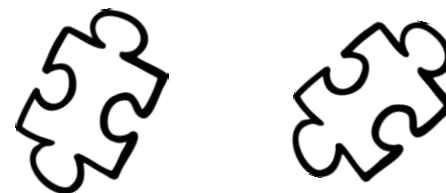
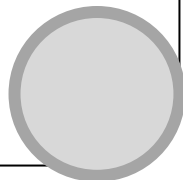
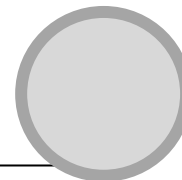
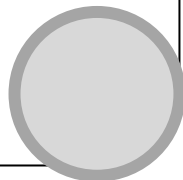
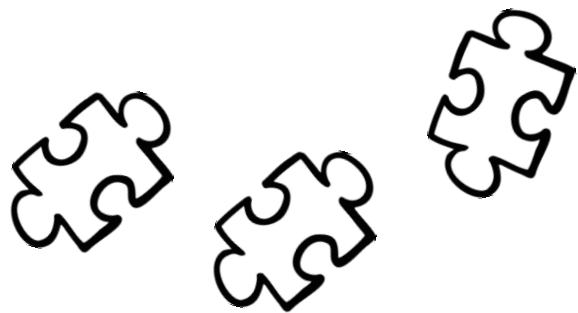

Dénombrer : compter et écrire/coller tamponner le résultat (entre zéro et trois)

---

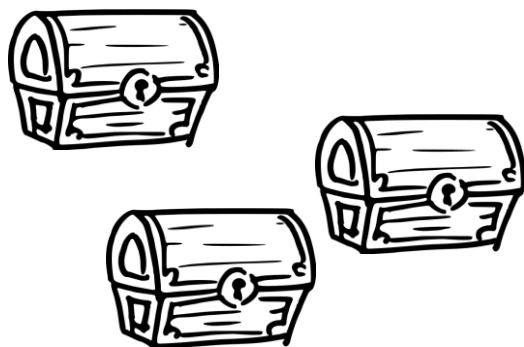
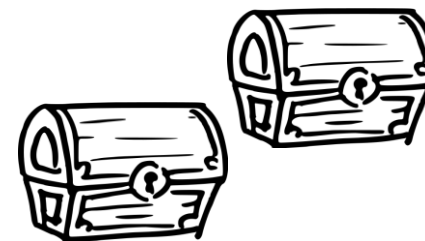



Dénombrement : compter et écrire/coller tamponner le résultat (entre zéro et trois)

---

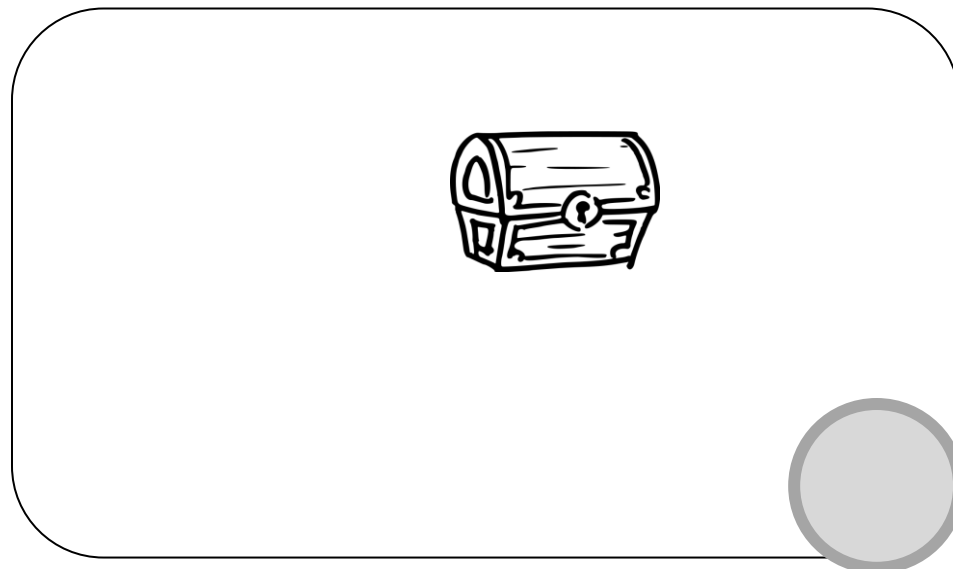
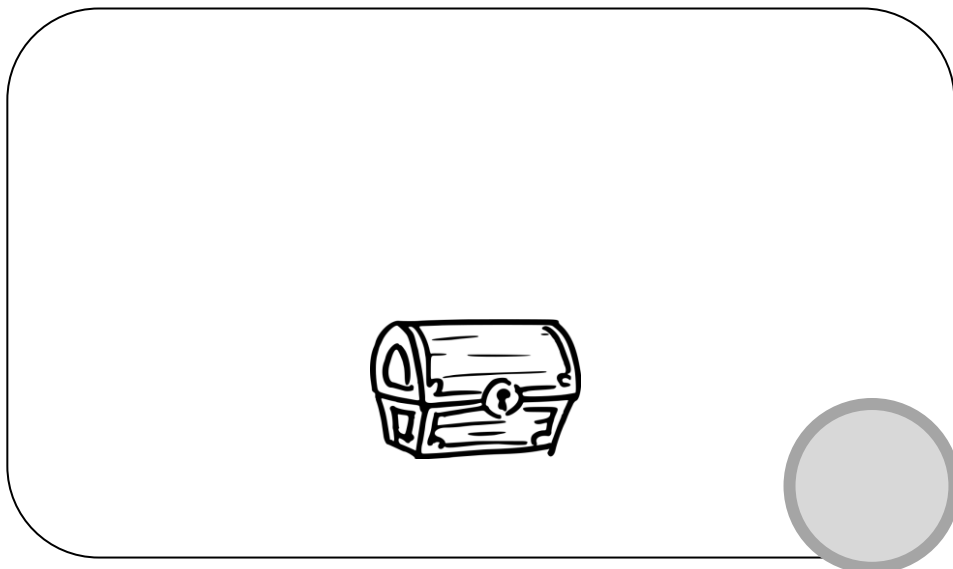
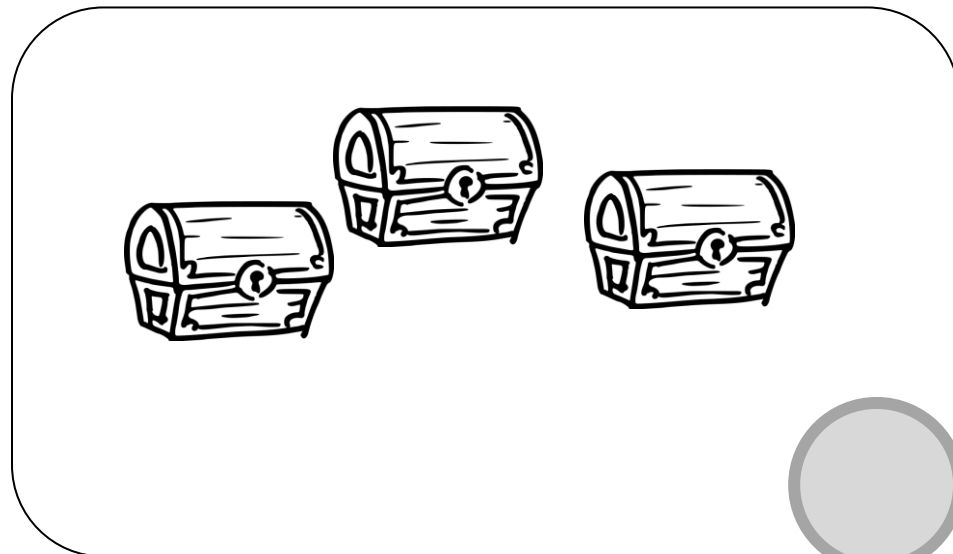

Dénombrer : compter et écrire/coller tamponner le résultat (entre un et trois)

---

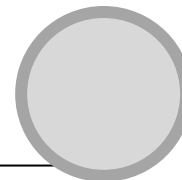
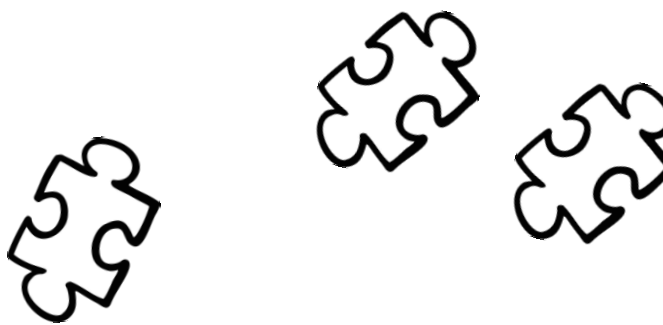
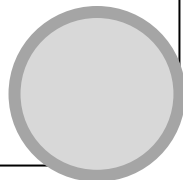
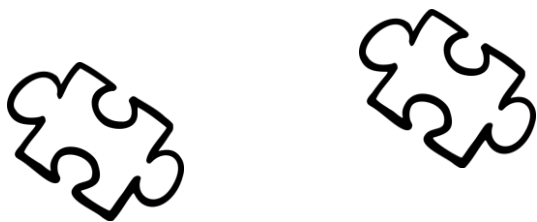
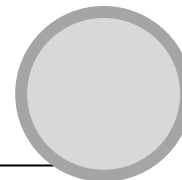
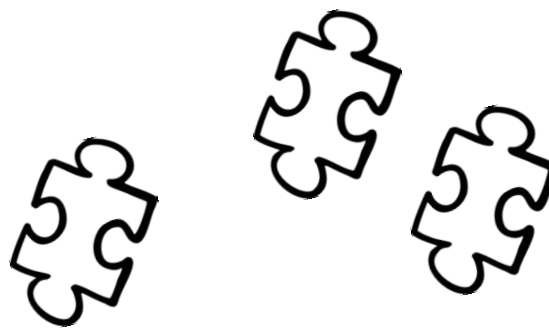
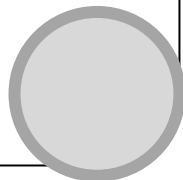

Dénombrément : compter et écrire/coller tamponner le résultat (entre zéro et trois)

---

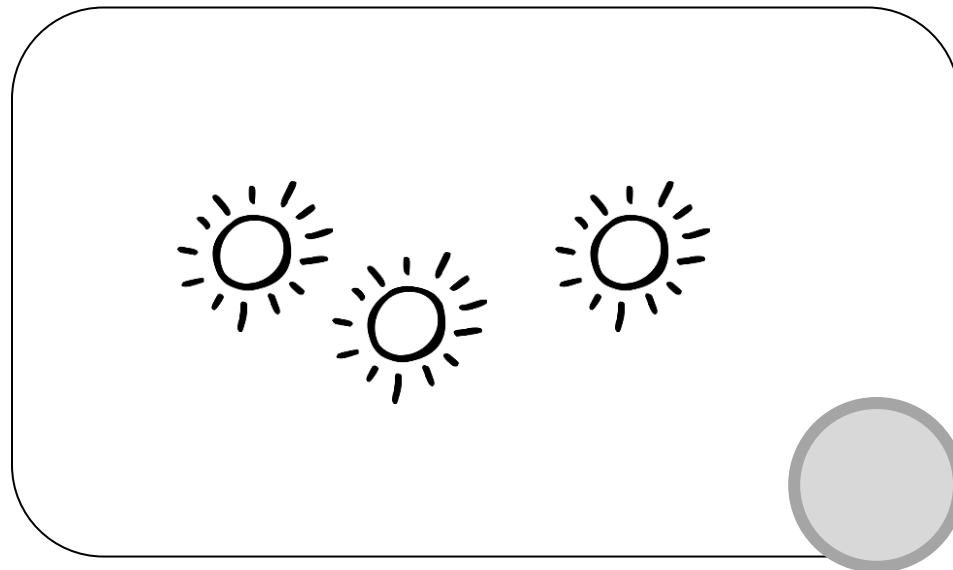
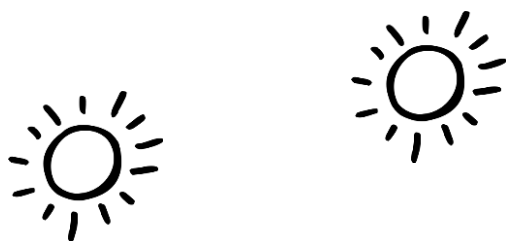
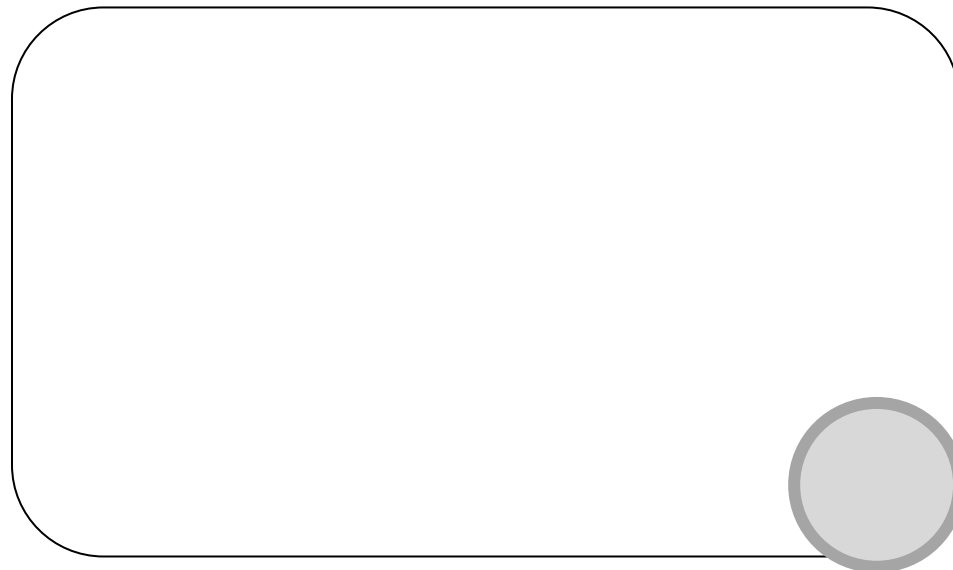
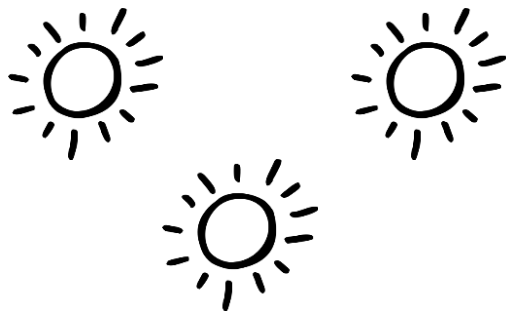

Dénombrer : compter et écrire/coller tamponner le résultat (entre zéro et trois)

---

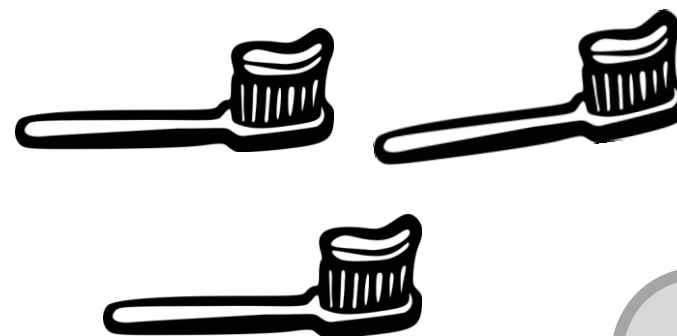
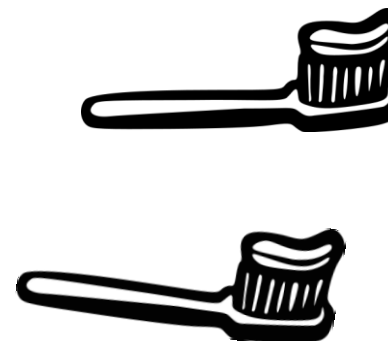
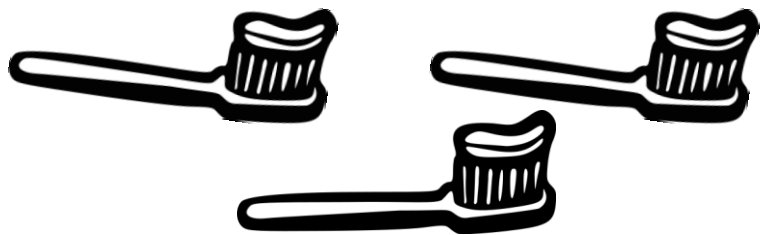

Dénombrer : compter et écrire/coller tamponner le résultat (entre zéro et trois)

---

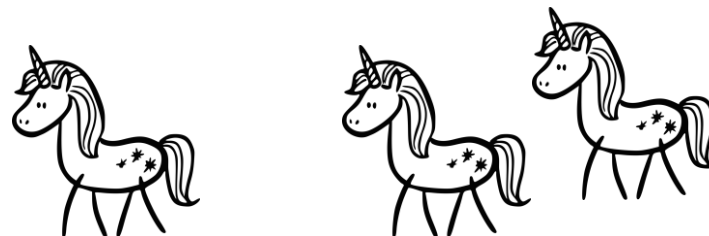
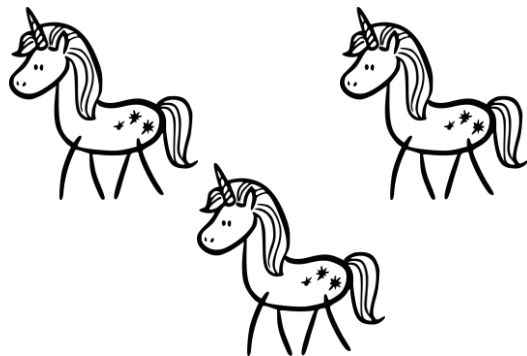

Dénombrer : compter et écrire/coller tamponner le résultat (entre zéro et trois)

---

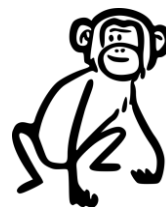
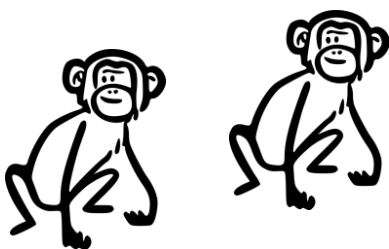
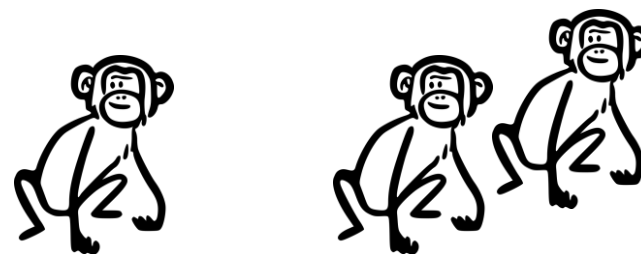
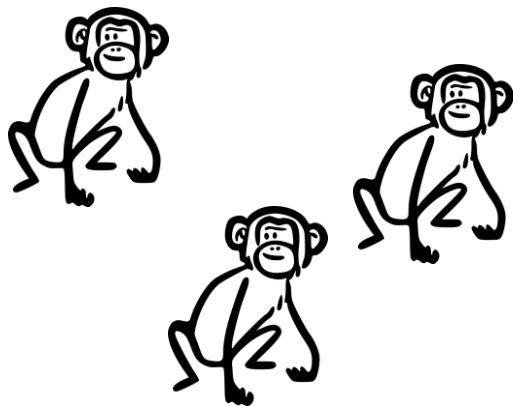

Dénombrer : compter et écrire/coller tamponner le résultat (entre un et trois)

---

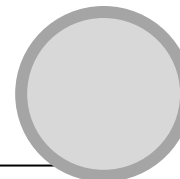
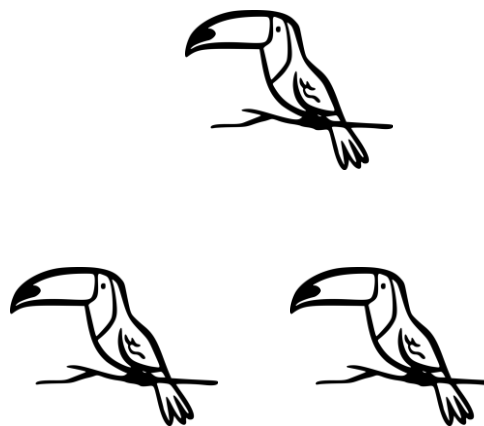
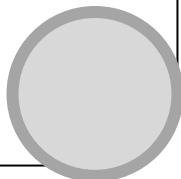
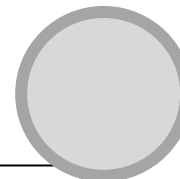
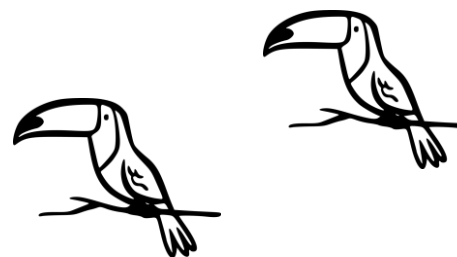
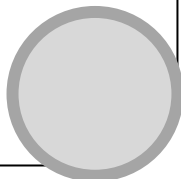

Dénombrer : compter et écrire/coller tamponner le résultat (entre un et trois)

---

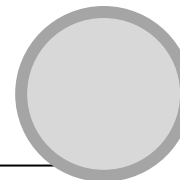
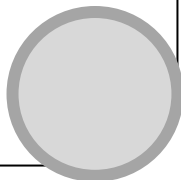
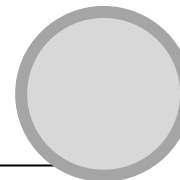
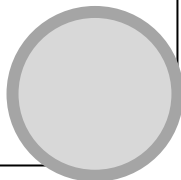



Dénombrer : compter et écrire/coller tamponner le résultat (entre un et trois)

---

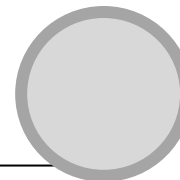
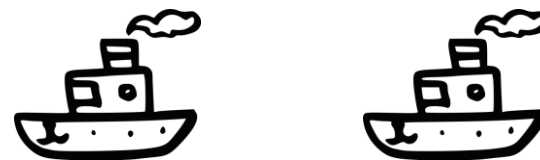
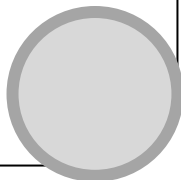
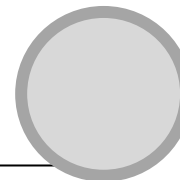
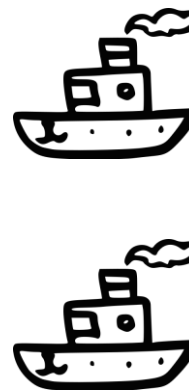
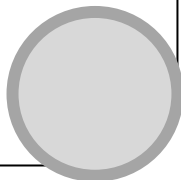
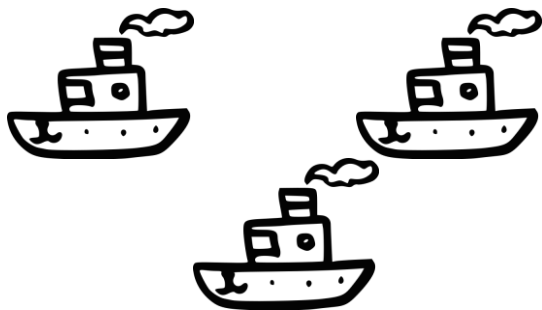

Dénombrer : compter et écrire/coller tamponner le résultat (entre un et trois)

---

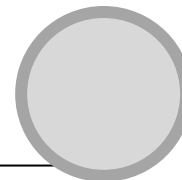
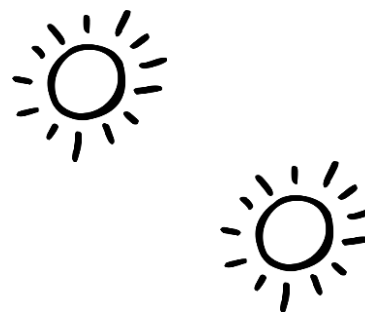
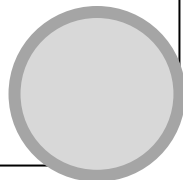
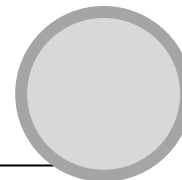
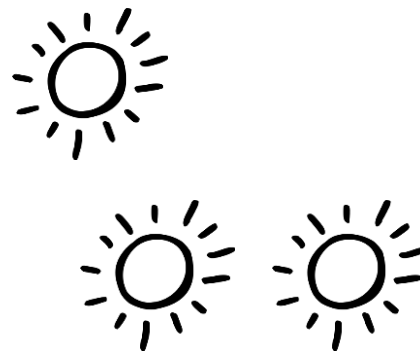
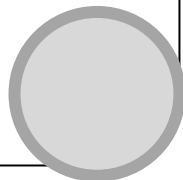
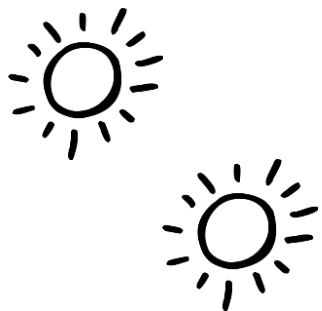

Dénombrer : compter et écrire/coller tamponner le résultat (entre un et quatre)

---

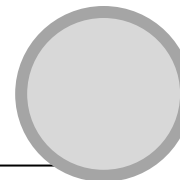
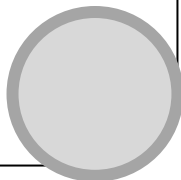
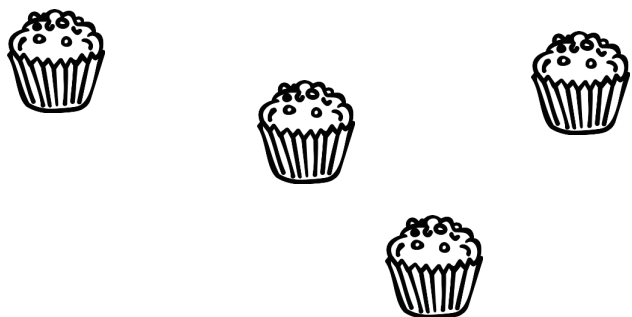
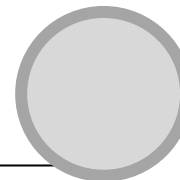
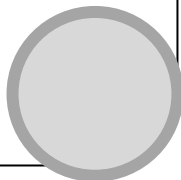

Dénombrement : compter et écrire/coller tamponner le résultat (entre un et quatre)

---

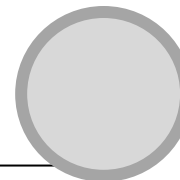
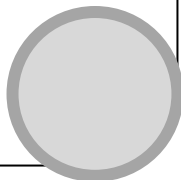
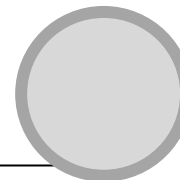
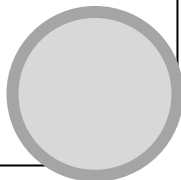

Dénombrement : compter et écrire/coller tamponner le résultat (entre zéro et quatre)

---

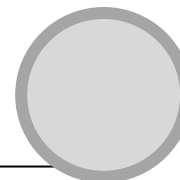
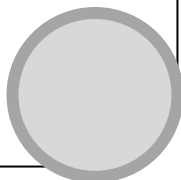
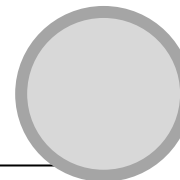
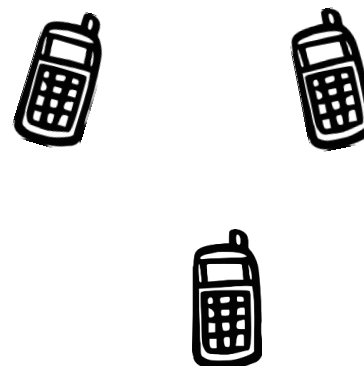
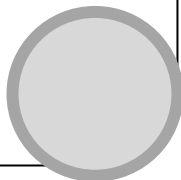
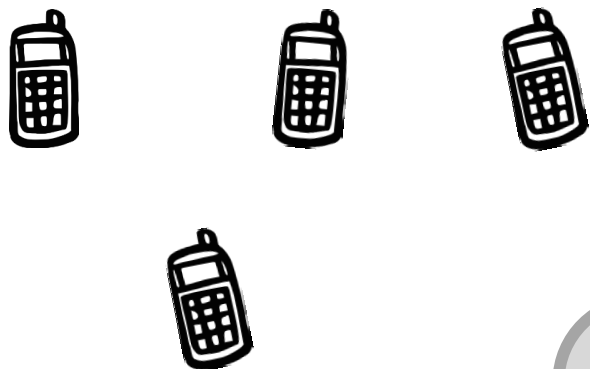

Dénombrement : compter et écrire/coller tamponner le résultat (entre un et quatre)

---

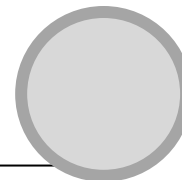
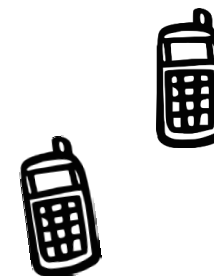
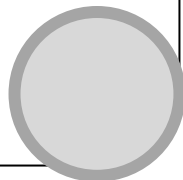
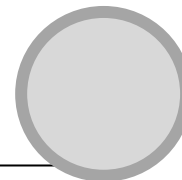
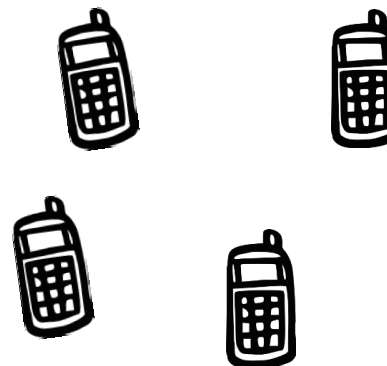
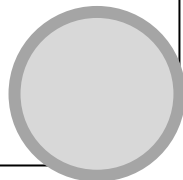
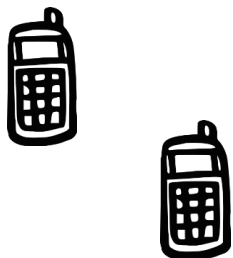

Dénombrement : compter et écrire/coller tamponner le résultat (entre zéro et quatre)

---



Dénombrer : compter et écrire/coller tamponner le résultat (entre zéro et quatre)

---

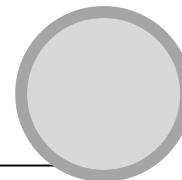
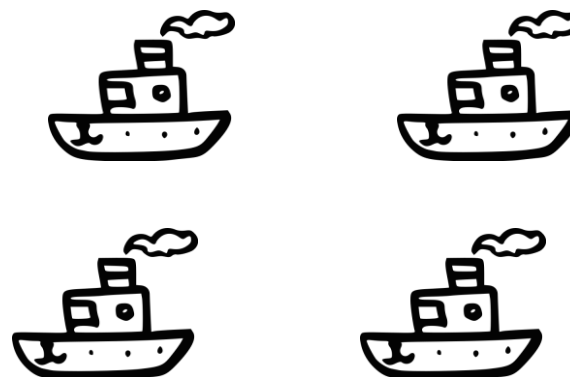
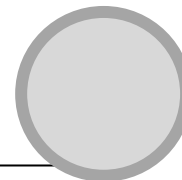
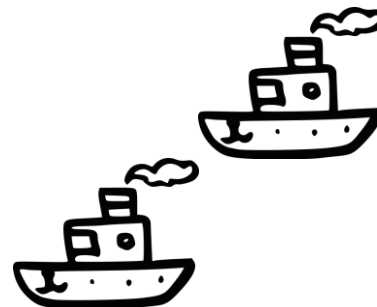
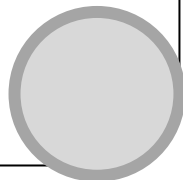
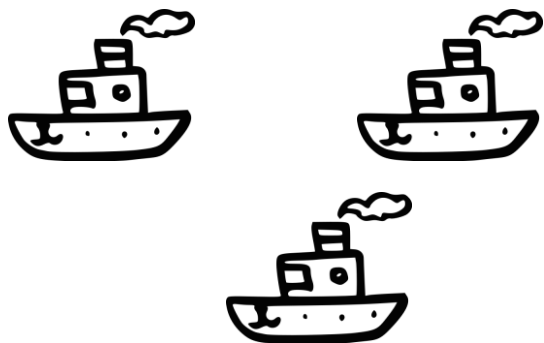



Dénombrément : compter et écrire/coller tamponner le résultat (entre zéro et quatre)

---

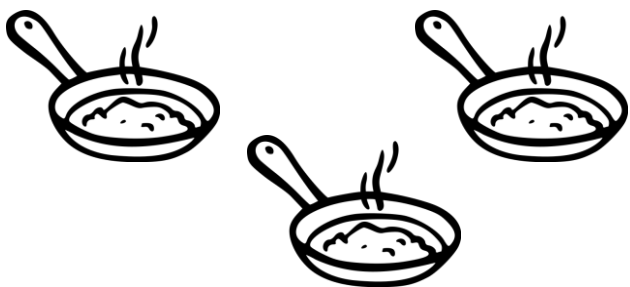
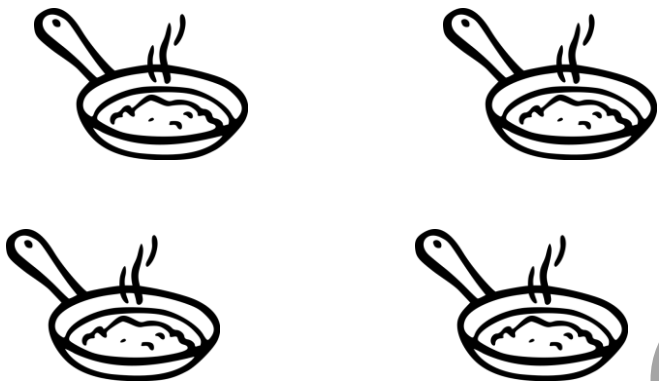

Dénombrer : compter et écrire/coller tamponner le résultat (entre zéro et quatre)

---

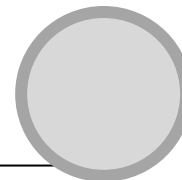
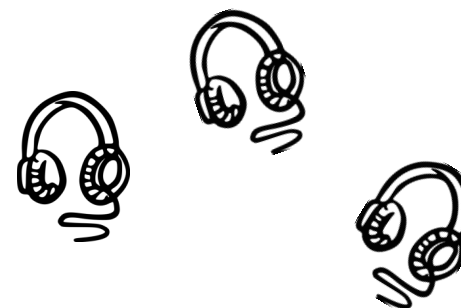
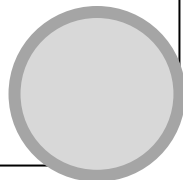
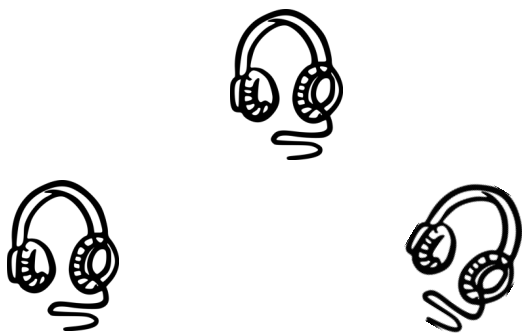
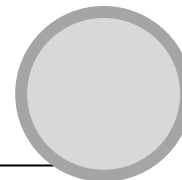
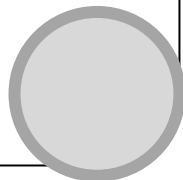

Dénombrément : compter et écrire/coller tamponner le résultat (entre zéro et quatre)

---

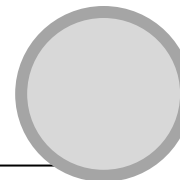
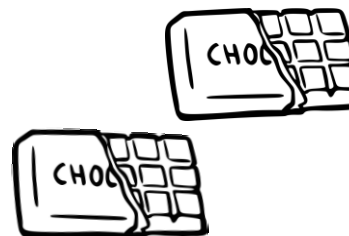
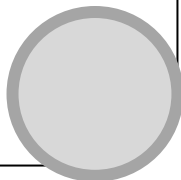
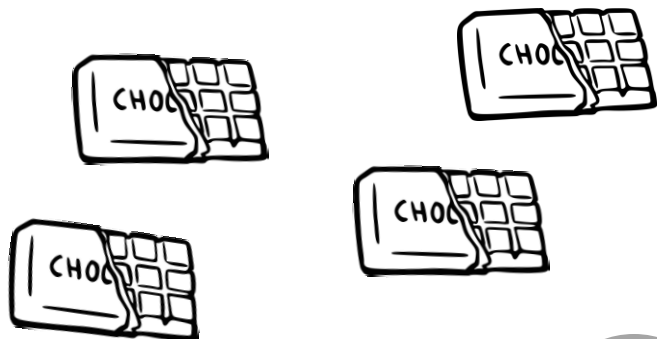
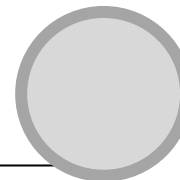
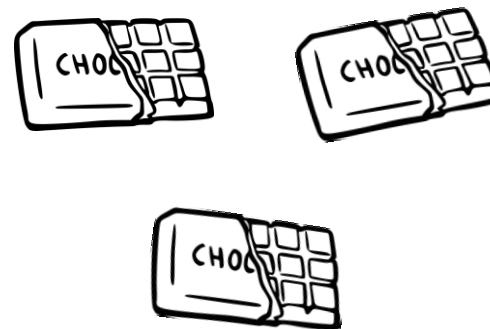
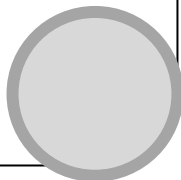

Dénombrement : compter et écrire/coller tamponner le résultat (entre zéro et quatre)

---

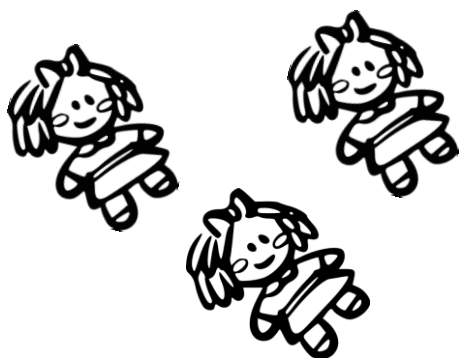
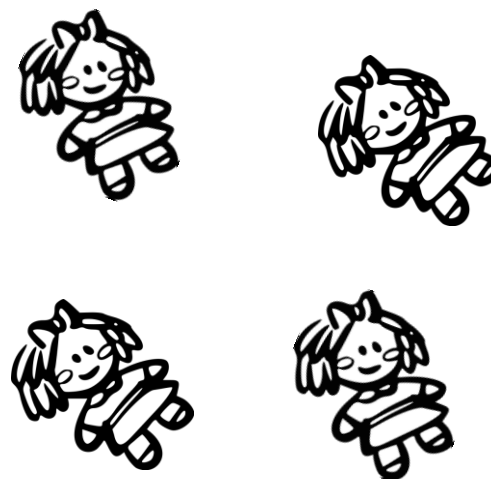
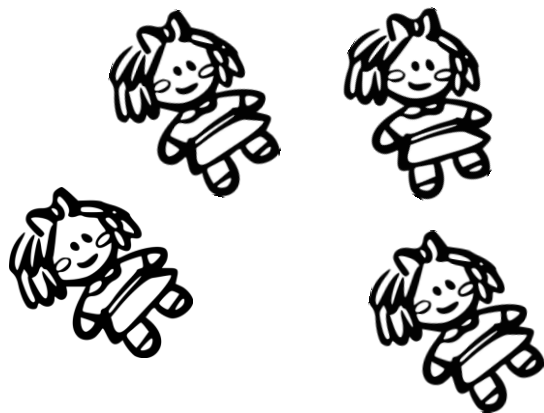

Dénombrer : compter et écrire/coller tamponner le résultat (entre un et quatre)

---

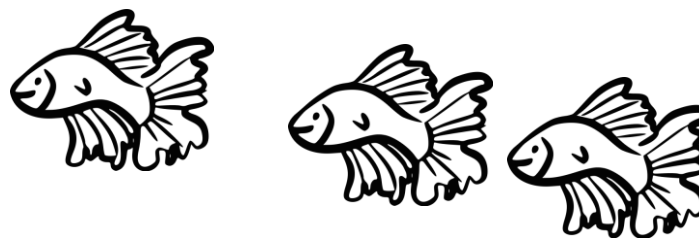
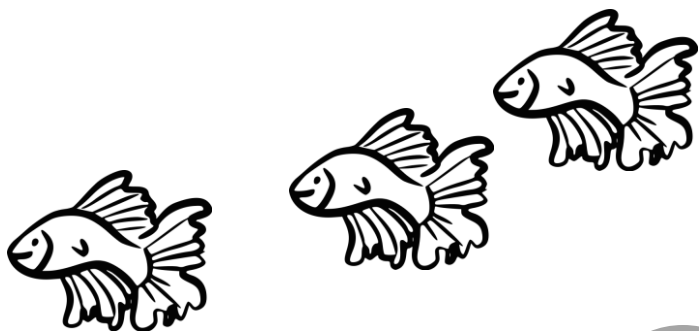
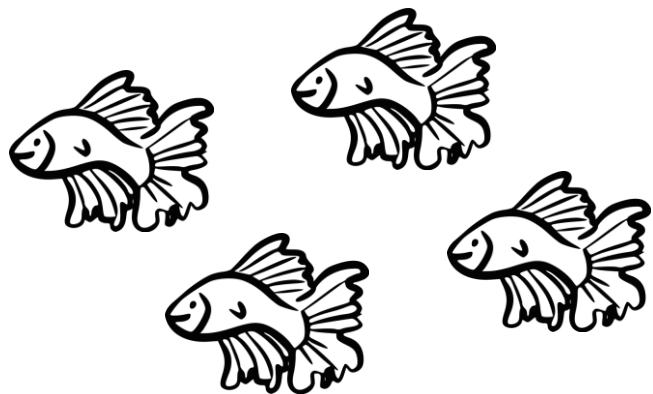

Dénombrer : compter et écrire/coller tamponner le résultat (entre un et quatre)

---

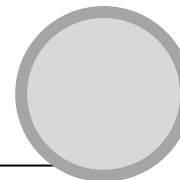
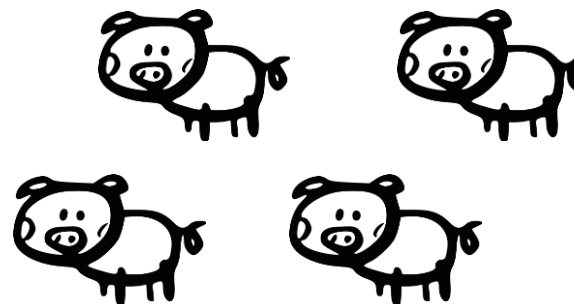
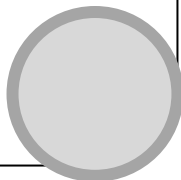
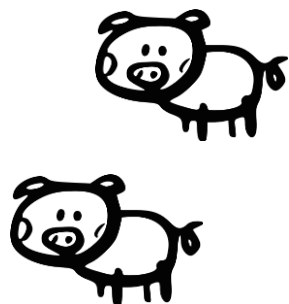
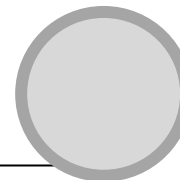
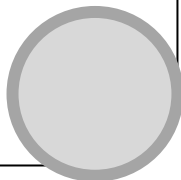
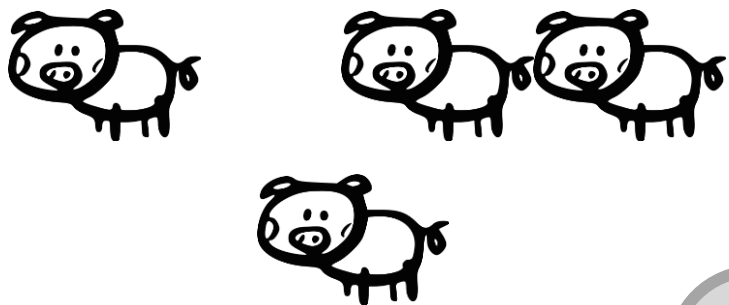

Dénombrer : compter et écrire/coller tamponner le résultat (entre un et quatre)

---

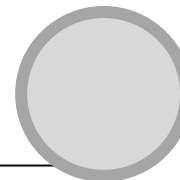
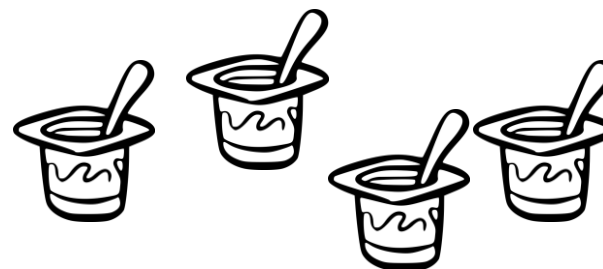
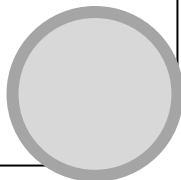
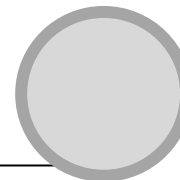
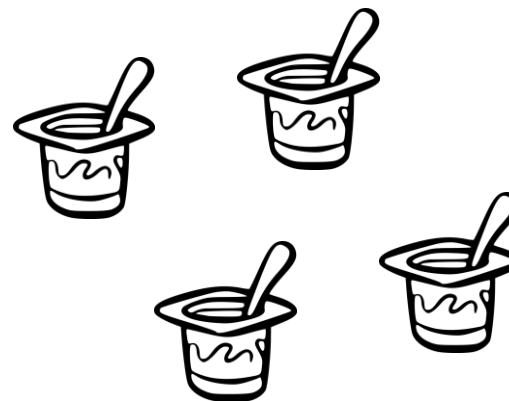
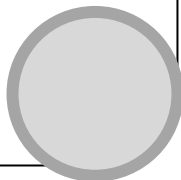

Dénombrement : compter et écrire/coller tamponner le résultat (entre un et quatre)

---





Dénombrer : compter et écrire/coller tamponner le résultat (entre un et quatre)

---

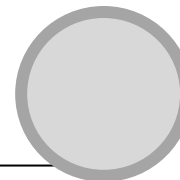
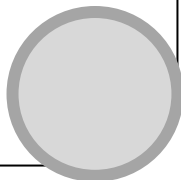
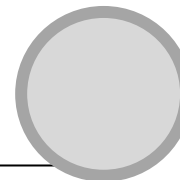
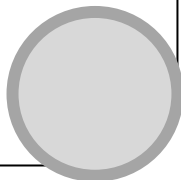

Dénombrement : compter et écrire/coller tamponner le résultat (entre un et quatre)

---

