

Trouve et associe :

une règle	
une agrafeuse	
une perforatrice	
un tampon	
un trombone	
une calculatrice	

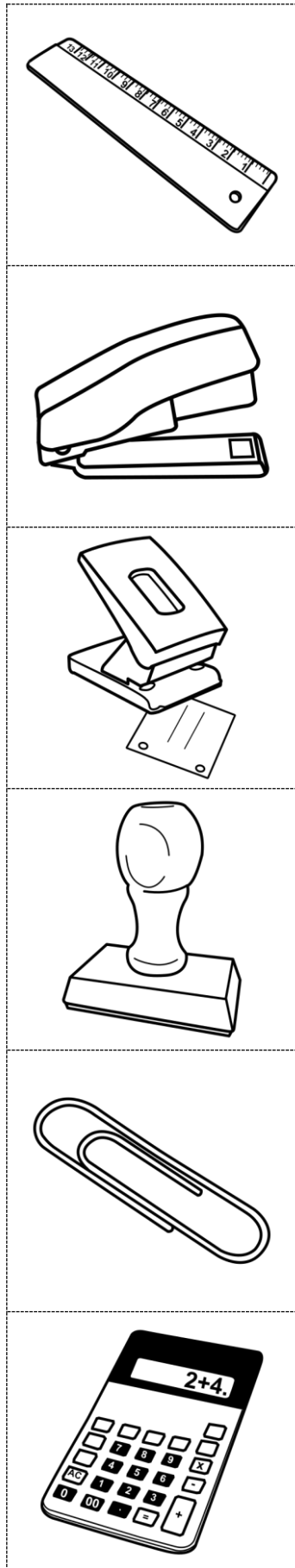

Trouve et associe :

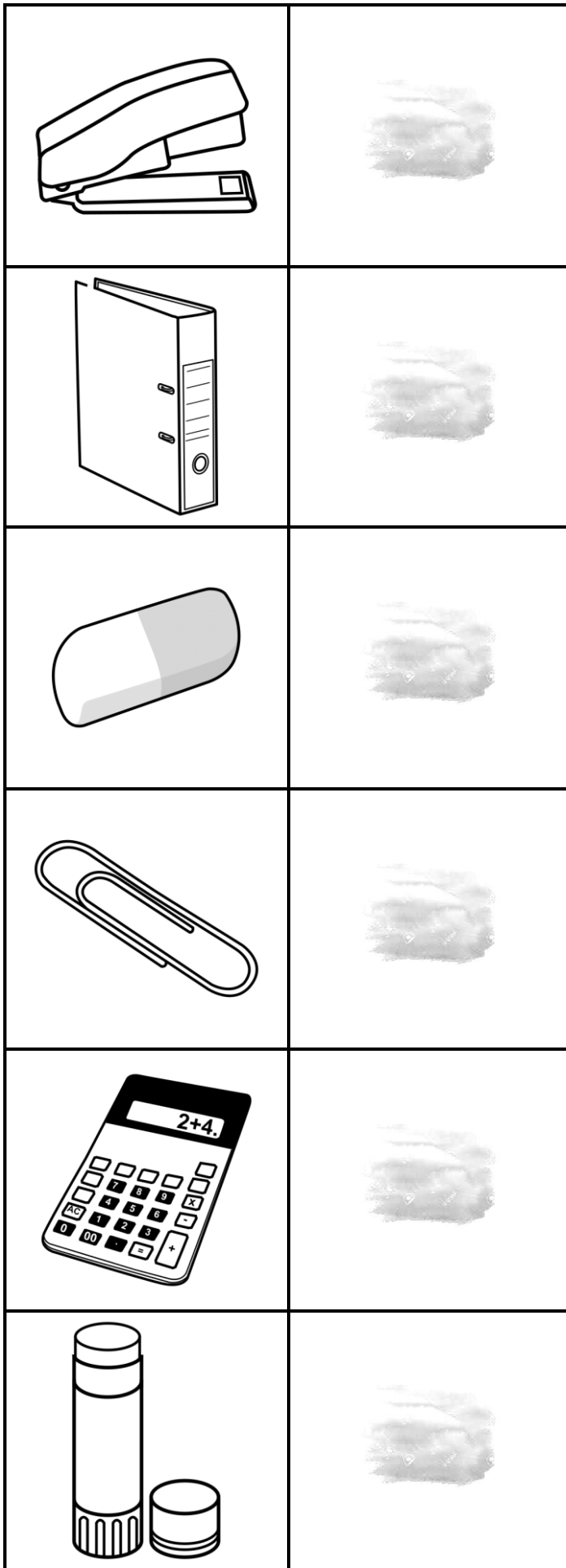

une gomme

une agrafeuse







une colle

un classeur

un trombone

une
calculatrice

Trouve et associe :

Une gomme	
Un taille-crayon	
Un classeur	
Un feutre-ardoise	
Une colle	
Un scotch	

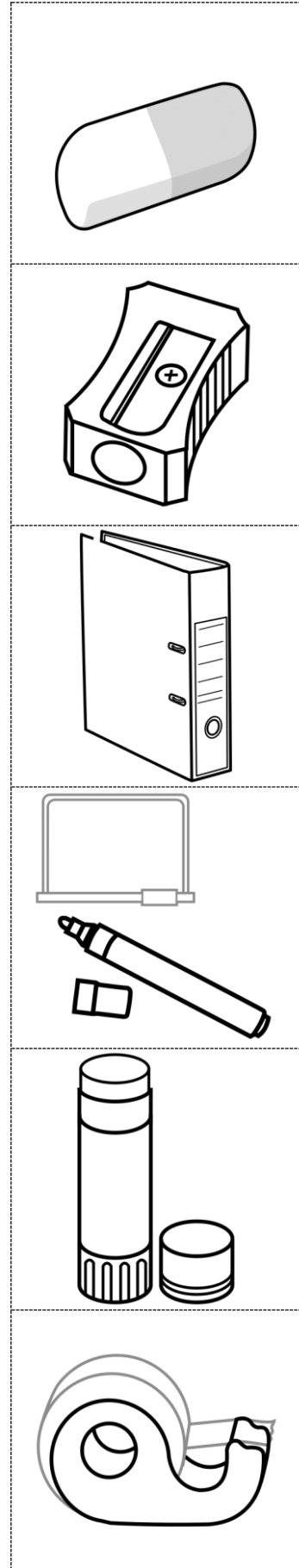

Trouve et associe :

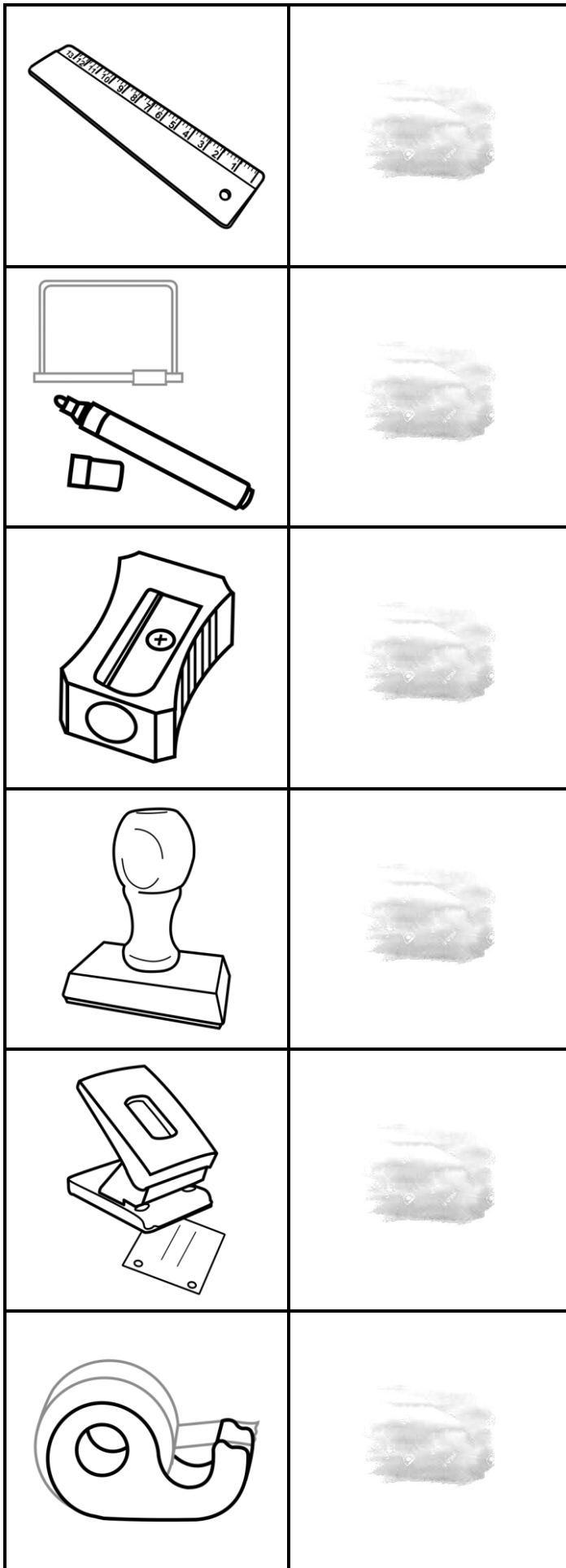

une règle

un taille-
crayon











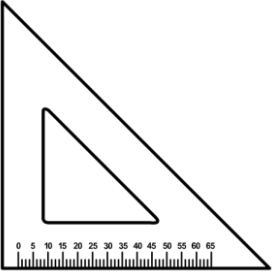

un tampon

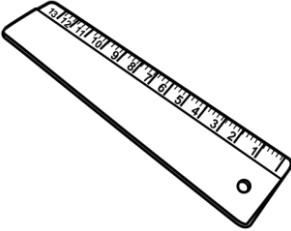
un feutre-
ardoise

une
perforatrice

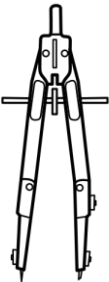
un scotch

Trouve et associe :

une équerre

un compas





une règle

une
calculatrice

les affaires







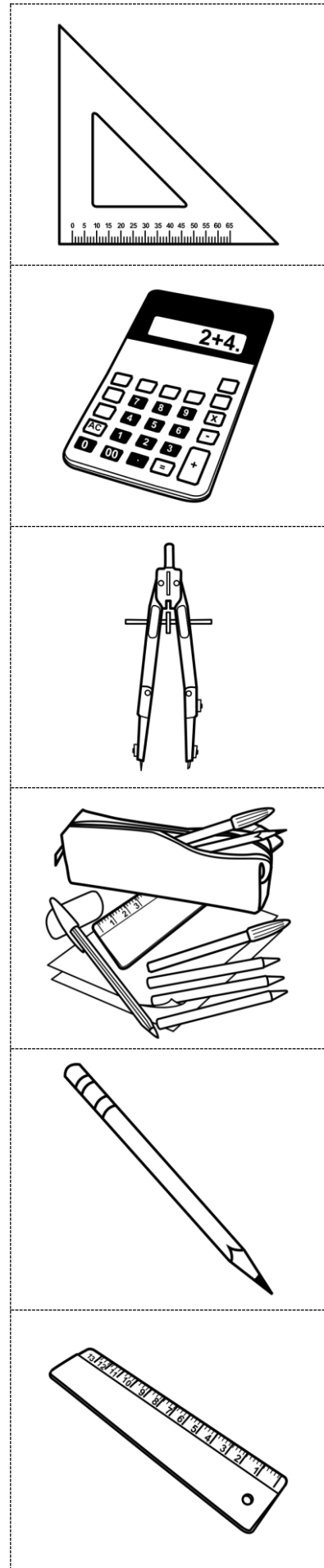



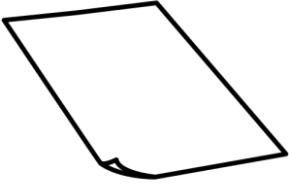

un crayon

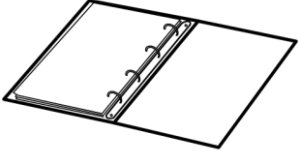
Trouve et associe :

une règle	
une calculatrice	
une équerre	
un compas	
un crayon	
les affaires	

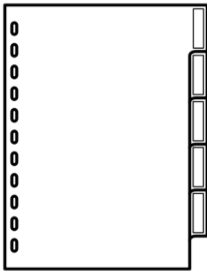

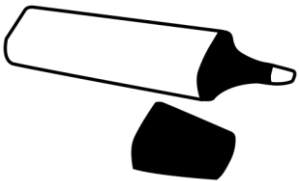
Trouve et associe :

les
intercalaires

un livre

un classeur

un surligneur

les étiquettes

une feuille

Trouve et associe :

un classeur	
un livre	
une feuille	
un intercalaire	
les étiquettes	
un surligneur	

